

The SCS200.6 system is shown here.

JBL

**SURROUND CINEMA
SPEAKERS**

SCS200.5/230 and
SCS200.6/230

OWNER'S GUIDE

®

READ FIRST! Important Safety Precautions!



CAUTION

RISK OF ELECTRIC SHOCK

DO NOT OPEN



CAUTION: TO REDUCE THE RISK OF ELECTRIC SHOCK, DO NOT REMOVE COVER (OR BACK). NO USER-SERVICEABLE PARTS INSIDE. REFER SERVICING TO QUALIFIED SERVICE PERSONNEL.



The lightning flash with arrowhead symbol, within an equilateral triangle, is intended to alert the user to the presence of uninsulated "dangerous voltage" within the product's enclosure that may be of sufficient magnitude to constitute a risk of electric shock to persons.



The exclamation point within an equilateral triangle is intended to alert the user to the presence of important operating and maintenance (servicing) instructions in the literature accompanying the appliance.

WARNING: TO REDUCE THE RISK OF FIRE OR ELECTRIC SHOCK, DO NOT EXPOSE THIS APPLIANCE TO RAIN OR MOISTURE.

1. Unpacking: Check the product carefully. If it has been damaged in transit, report the damage immediately by calling your dealer and/or the shipping company that delivered it.

2. Connections: Whenever changing, connecting or disconnecting signal or power cables etc., always turn off all equipment. This prevents transients from entering the equipment and prevents electrical energy from reaching you. Keep all connections out of the reach of children. Before moving the unit, be certain to disconnect any interconnection cords with other components, and make certain that you disconnect any powered units from the AC outlet.

3. Read Instructions. All the safety and operating instructions should be read before the product is operated.

4. Retain Instructions. The safety and operating instructions should be retained for future reference.

5. Heed Warnings. All warnings on the product and in the operating instructions should be adhered to.

6. Follow Instructions. All operating and use instructions should be followed.

7. Water and Moisture. The product should not be used near water – for example, near a bathtub, washbowl, kitchen sink, laundry tub, in a wet basement, or near a swimming pool, and the like.

8. Accessories. To ensure proper operation and to avoid the potential for safety hazards, place the unit on a firm and level surface. When placing the unit on a shelf, be certain that the shelf and any mounting hardware can support the product's weight.



Do not place this product on an unstable cart, stand, tripod, bracket, or table. The product may fall, causing serious

injury to a child or adult, and serious damage to the product. Use only with a cart, stand, tripod, bracket, or table recommended by the manufacturer, or sold with the product. Any mount-

ing of the product should follow the manufacturer's instructions, and should use a mounting accessory recommended by the manufacturer.

9. Wall or Ceiling Mounting. The product should be mounted on a wall or ceiling only when and as recommended by the manufacturer.

10. Cleaning. Unplug this product from the wall outlet before cleaning. Do not use liquid cleaners or aerosol cleaners. Use a dry cloth for cleaning.

11. Attachments. Do not use attachments not recommended by the product manufacturer, as they may cause hazards.

12. Replacement Parts. When replacement parts are required, be sure the service technician has used replacement parts specified by the manufacturer or that have the same characteristics as the original part. Unauthorized substitutions may result in fire, electric shock or other hazards.

13. Safety Check. Upon completion of any service or repairs to this product, ask the service technician to perform safety checks to determine that the product is in proper operating condition.

14. Feet/Spikes. When positioning, or moving this product ensure that is lifted rather than dragged across any floor/mounting surface. This will avoid any damage to the floor/mounting surface. Attention! Products and/or product feet constructed

of rubber or plastics may, in seldom cases, react chemically and discolor treated or non-treated wooden surfaces if positioned without protection.

15. Warranty: The following conditions may result in a void product warranty:

- a. the manufacturer's serial number is removed or forged.
- b. if repairs and/or modifications and/or other treatments/tunings have been carried out by non-authorized personnel or accessories/supplements are attached, which are not approved by manufacturer/importer.

16. Warranty: The following items are not covered by the product warranty:

- a. Damage caused by inappropriate handling despite clear instructions provided in the owners manual.
- b. Damage to mechanical parts (such as record-/playback heads, moving rubber and plastic parts and fuses) as well as results of normal wear and tear.
- c. Damage caused by external action or influence.
- d. Damage caused by misuse by user.
- e. Damage caused by excessive electrical mains supply voltage or lightning strike.
- f. Damage caused by fire, water or smoke.
- g. Damage known to buyer prior to purchase.
- h. Damage caused by professional employment of home entertainment products (e.g. for catering trade, restaurants, public address or infinite loop announcement use etc.)

17. If an outside antenna or cable system is connected to the product, be sure the antenna or cable system is grounded so as to provide some protection against voltage surges and built-up static charges. Article 810 of the National Electrical Code, ANSI/NFPA 70, provides information with regard to proper grounding of the mast and supporting structure, grounding of the lead-in wire to an

Figure A.
Example of Antenna Grounding as per National Electrical Code ANSI/NFPA 70

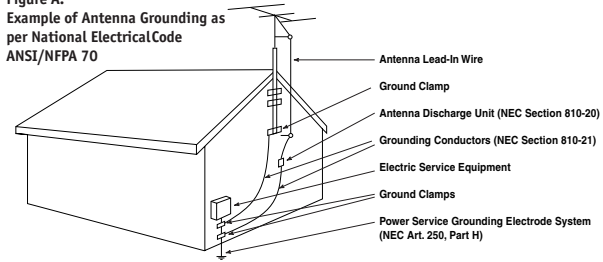

antenna discharge unit, size of grounding conductors, location of antenna-discharge unit, connection to grounding electrodes, and requirements for the grounding electrode. See Figure A.

18. An outside antenna system should not be located in the vicinity of overhead power lines or other electric light or power circuits, or where it can fall into such power lines or circuits. When installing an outside antenna system, extreme care should be taken to keep from touching such power lines or circuits, as contact with them might be fatal.

19. Specifications: All product specifications/features are subject to change without notification.

Passive Products:

20. Amplifiers: Amplifiers used to drive these units must deliver a sufficient output power. A lack of output power may lead to amplifier-clipping, which causes damage not covered by guarantee.

Active (Powered) Products:

21. Ventilation. Slots and openings in the cabinet are provided for ventilation and to ensure reliable operation of the product and to protect it from overheating, and these openings must not be blocked or covered. The openings should never be blocked by placing the product on a bed, sofa, rug, or other similar surface. This product should not be placed in a built-in installation such as a bookcase or rack unless proper ventilation is provided or the manufacturer's instructions have been adhered to. Make certain that the proper space (more than 10cm) is provided both above and below the unit for ventilation. If the amplifier will be installed in a cabinet or other enclosed area, make certain that there is sufficient air movement within the cabinet, with means provided for hot air to exit and for cool air to be brought in.

Do not obstruct the ventilation slots on the top of the unit or place objects directly over them. Remember, power amplifiers generate heat, and the heatsink fins and ventilation slots that form part of the cabinet are specially designed to remove this heat. Placing other electronic equipment near these heat-dissipation systems may possibly affect the long term reliability of both your amplifier and the objects placed above it. Do not place CDs, record jackets, owner's manuals or other paper on top of or beneath the unit or in between products containing amplifiers in a stack. This will block the air flow, causing degraded performance and a possible fire hazard.

22. Power Sources. This product should be operated only from the type of power source indicated on the marking label. If you are not sure of the type of power supply to your home, consult your product dealer or local power company. For products intended to operate from battery power, or other sources, refer to the operating instructions.

23. Grounding or Polarization. This product may be equipped with a polarized alternating-current line plug (a plug having one blade wider than the other). This plug will fit into the power outlet only one way. This is a safety feature. If you are unable to insert the plug fully into the outlet, try reversing the plug. If the plug should still fail to fit, contact your electrician to replace your obsolete outlet. Do not defeat the safety purpose of the polarized plug.

24. Power-Cord Protection. Power-supply cords should be routed so that they are not likely to be walked on or pinched by items placed upon or against them, paying particular attention to cords at plugs, convenience receptacles, and the point where they exit from the product. To avoid safety hazards, use only the power cord supplied with your unit. If a replacement cord is used, make certain that it is of a similar gauge. We do not recommend using extension cords with this product. As with all electrical devices, do not run power cords under rugs or carpets or place heavy objects on power cords. Damaged power cords should be replaced immediately, by a qualified service technician, with cords meeting factory specifications. When disconnecting the power cord from an AC outlet, always pull the plug; never pull the cord.

25. Non-use Periods. The power cord of the product should be unplugged from the outlet when left unused for long periods of time.

26. Lightning. For added protection for this product during a lightning storm, or when it is left unattended and unused for long periods of time, unplug it from the wall outlet and disconnect the antenna or cable system. This will prevent damage to the product due to lightning and power-line surges.

27. Overloading. Do not overload wall outlets, extension cords, or integral convenience receptacles, as this can result in a risk of fire or electric shock.

28. Damage Requiring Service. Do not attempt to service this product yourself, as opening or removing covers may expose you to dangerous voltage or other hazards. Unplug this product from the wall outlet and refer servicing to qualified service personnel under the following conditions:

- The power-supply cord or the plug has been damaged; or
- Objects have fallen, or liquid has been spilled into, the product; or
- The product has been exposed to rain or water; or
- The product does not operate normally when following the operating instructions. Adjust only those controls that are covered by the operating instructions, as an improper adjustment of other controls may result in damage and will often require extensive work by a qualified technician to restore the product to its normal operation; or
- The product has been dropped, or the enclosure damaged; or
- The product does not appear to operate normally or exhibits a marked change in performance.

29. Object and Liquid Entry. Never push objects of any kind into this product through openings, as they may touch dangerous voltage points or short-out parts that could result in a fire or electric shock. Never spill liquid of any kind on the product. The apparatus shall not be exposed to dripping or splashing and no objects filled with liquids, such as vases, shall be placed on the apparatus.

30. Heat. The product should be situated away from heat sources such as radiators, heat registers, stoves or other products (including amplifiers) that produce heat. Avoid installation in extremely hot or cold locations, in an area that is exposed to direct sunlight or near heating equipment.

When positioning the product in its final location, make certain that it has adequate ventilation on all sides, as well as on the top and bottom.

THANK YOU FOR CHOOSING JBL

For more than 50 years, JBL has been involved in every aspect of music and film recording and reproduction, from live performances to the recordings you play in your home, car or office.

We're confident that the JBL system you have chosen will provide every note of enjoy-

ment that you expected – and that when you think about purchasing additional audio equipment for your home, car or office, you will once again choose JBL.

Please take a moment to register your product on our Web site at www.jbl.com. It enables us to keep you

posted on our latest advancements, and helps us to better understand our customers and build products that meet their needs and expectations.

JBL Consumer Products

INCLUDED

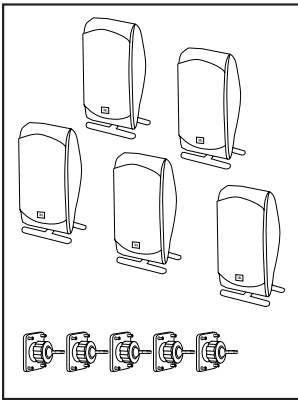

Five (four in SCS200.5 system) satellites for left, right and surrounds. Wall-mount brackets. Shelf stands.

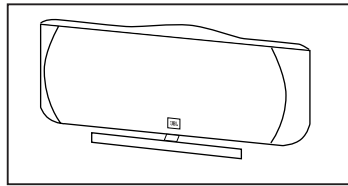

One center channel speaker with shelf stand.

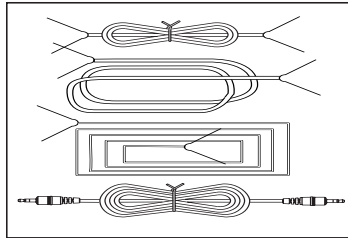

Three 6m (20') speaker cables for connection to front, left, center and right speakers, or to subwoofer when speaker-level connections are used (see page 10).

Two 4.6m (15') speaker cables for connection from subwoofer to front speakers, when speaker-level connections are used (see page 10).

Three (two in SCS200.5 system) 12m (40') speaker cables for connection from receiver to rear satellites.

One 4.6m (15') RCA interconnect cable for connection from receiver to subwoofer's LFE input.

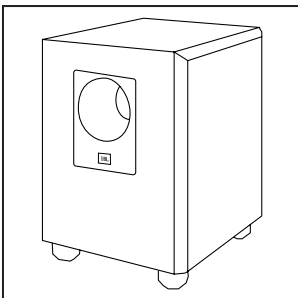

Powered subwoofer.

SPEAKER PLACEMENT

FRONT SPEAKERS

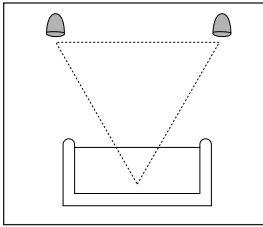

CENTER CHANNEL SPEAKER

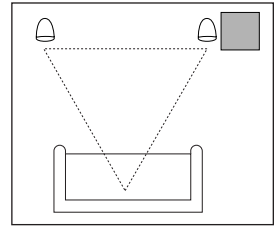
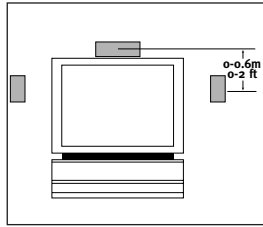

SURROUND SPEAKERS

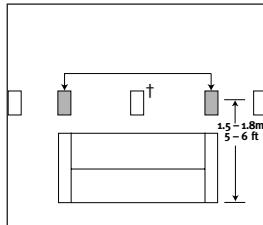
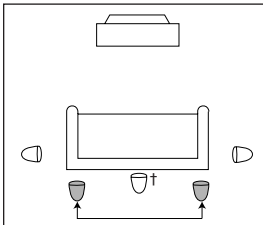

Alternate placement for surround speakers in SCS200.5 system only.

† Surround back speaker is used only in SCS200.6 system.

The front speakers should be placed the same distance from each other as they are from the listening position. They should be placed at about the same height from the floor as the listeners' ears will be, or they may be angled toward the listeners.

The center channel speaker should be placed slightly behind the front left and right speakers, and no more than two feet above or below the tweeters of the left and right speakers. It is often convenient to set the center speaker on top of the television set, as shown in the drawing.

Two of the surround speakers should be placed slightly behind the listening position and, ideally, should face each other and be at a level

higher than the listeners' ears. If that is not possible, they may be placed on a wall behind the listening position, facing forward. The surround back speaker (SCS200.6 system only) should be placed on the wall behind the listening position, facing the center channel speaker. The surround speakers should not call attention to themselves. Experiment with their placement until you hear a diffuse, ambient sound accompanying the main program material heard in the front speakers.

It is neither necessary nor desirable to tilt the surround speakers to aim them down toward the listening area. They should be aimed straight ahead to produce the proper effect.

The low-frequency material reproduced by the subwoofer is mostly omnidirectional, and this speaker may be placed in a convenient location in the room. However, bass reproduction will be maximized when the subwoofer is placed in a corner along the same wall as the front speakers. Experiment with subwoofer placement by temporarily placing the subwoofer in the listening position and moving around the room until the bass reproduction is best. Place the subwoofer in that location.

MOUNTING OPTIONS

SATELLITES AND SURROUNDS

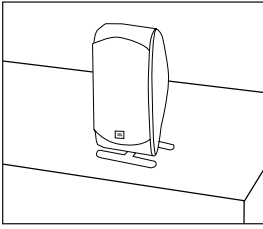

On shelves.

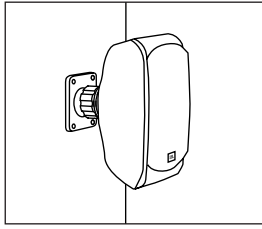

On the wall.
Wall brackets are included.

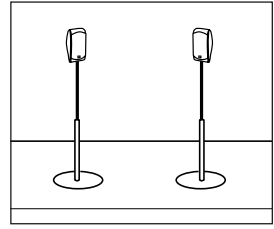

On optional stands.

ATTACHING THE SHELF STAND TO THE SPEAKER

Prepare the speaker wire as described on page 8. Thread the two conductors through the two holes in the stand bracket. Make sure to preserve the proper polarity (+ and - connections) by threading the positive conductor through the hole on

the left, and the negative conductor through the hole on the right looking at the front of the stand. Push down on the red speaker terminal and insert the bare end of the positive wire into the hole under the red cap. Release the cap, and tug

gently on the wire to make sure that the connection is snug. Follow the same procedure to connect the negative wire to its terminal. Use the larger screw in the upper screw hole, and the smaller screw in the lower screw hole

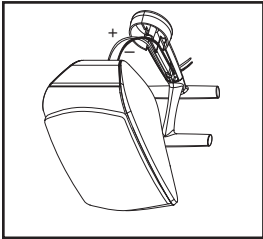

Gently pull the slack out of the wire and screw the shelf stand onto the back of the speaker in two places, as shown.

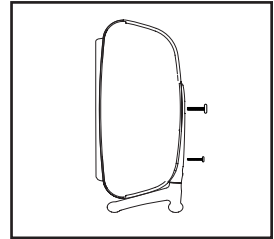

WALL-MOUNTING

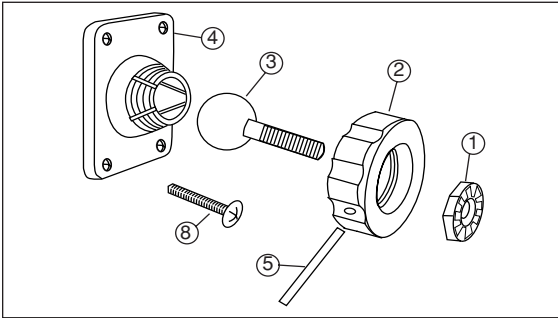

Important Safety Note: The customer is solely responsible for proper selection of mounting hardware not included with the speakers, and for proper assembly and installation of the wall-brackets, including but not limited to the selection of appropriate weight-bearing supports and proper use of the bracket. JBL disclaims any liability for the selection of mounting hardware and/or bracket installation. Be sure to follow these bracket assembly and installation instructions carefully. If you have any questions or doubts about your ability to correctly wall-mount the speakers, consult with your authorized JBL dealer or custom installer.

Step 1: Unscrew and remove the large **Molded Nut 2**. If necessary, use the supplied **Metal Bar 5** as a lever by inserting it into one of the holes in the outer edge of the **Molded Nut 2**.

Step 2: Firmly grasp the **Ball and Shaft 3** and pull it straight out of the **Attachment Plate 4**. Avoid leaning it to the side for leverage, as this may break off a tab.

Step 3: Slide the **Molded Nut 2** onto the **Ball and Shaft 3** with the threaded opening facing the ball. Thread the **Metal Nut 1** all the way onto the **Ball and Shaft 3**, with the star washer side away from the ball. Refer to the exploded drawing for the proper orientation of these three parts.

Step 4: Screw the **Ball and Shaft 3** into the **Threaded Insert 6** on the back of the **Satellite Speaker 7** until it is fully seated in the **Threaded Insert 6**, but *do not* tighten as you might dislodge the **Threaded Insert 6**. Such damage would not be covered under the warranty.

Step 5: Tighten the **Metal Nut 1** with the star washer side between the **Metal Nut 1** and the back of the **Satellite Speaker 7**, using large needle-nose pliers until it is firmly seated against the back of the **Speaker 7** and has locked the **Ball and Shaft 3** and the **Speaker 7** together.

Note that once the **Metal Nut 1** is fully tightened, it may embed some marks on the back of the **Satellite Speaker 7**. However, these marks will be covered by the **Metal Nut 1**.

Step 6: Mount the **Attachment Plate 4** into a wood stud on the wall, using four #10 pan-head wood screws at least one inch long (not supplied) **8**.

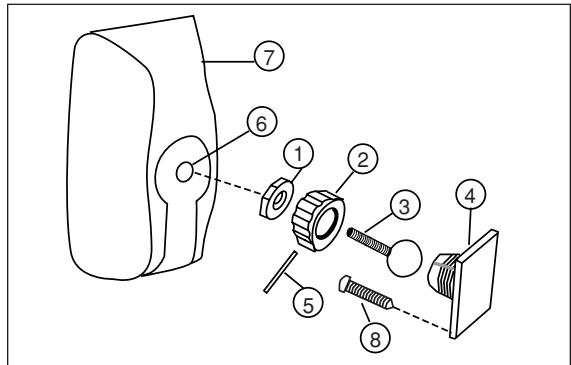

Make sure that all four screws are driven into the stud and not into drywall.

If the bracket needs to be mounted in drywall, the customer is responsible for selecting and using appropriate wall-anchors and screws.

Important Note: The **Metal Nut 1** must be fully tightened against the **Satellite**

Speaker 7 as described in Step 5 before beginning Step 7 in order to avoid damage to the **Threaded Insert 6**.

Such damage would not be covered under the warranty.

Step 7: Holding the **Satellite Speaker 7** with both hands, reinsert the ball portion of the **Ball and Shaft 3** into the **Attachment Plate 4**.

Step 8: Hand-tighten the **Molded Nut 2** while positioning the speaker for the desired orientation.

If the **Molded Nut 2** is difficult to tighten by hand, insert the **Metal Bar 5** into one of

the holes in the outer edge of the **Molded Nut 2** and use the bar as a lever. Be careful not to cross-thread.

The swiveling ball enables you to aim the speaker to one side or the other, or to tilt it up or down. Although stereo imaging may be improved by aiming the front speakers toward the listening position, especially for music selections, the surround speakers are intended to provide a diffuse, ambient sound that is best achieved by aiming the speakers straight out from the wall.

Aiming the surround speakers toward the listening position may ruin the intended effect by calling too much attention to the information in those channels.

Step 9: Once the speaker's orientation has been finalized, insert the **Metal Bar 5** into one of the holes in the outer edge of the **Molded Nut 2** and tighten the **Molded Nut 2** securely. Keep the **Metal Bar 5** in a safe place in the event that you decide to adjust the speaker's orientation in the future.

SPEAKER CONNECTIONS

CONNECTION TIPS

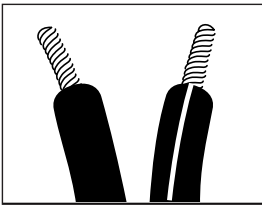

Separate and strip the ends of the speaker wire as shown. The wires supplied with the system may already be stripped and tinned for easy insertion into the speaker terminals. You may need to separate the two conductors further in order to thread them through the shelf stand or floor stand adaptor. Speakers and electronics terminals have corresponding (+) and (-) terminals. Most manufacturers of speakers and electronics, including JBL, use red to denote the (+) terminal and black to denote the (-) terminal.

The (+) lead of the speaker wire is noted with a stripe. It is important to connect both speakers identically: (+) on the speaker to (+) on the amplifier and (-) on the speaker to (-) on the amplifier. Wiring “out of phase” results in thin sound, weak bass and a poor stereo image.

With the advent of multi-channel surround sound systems, connecting all of the speakers in your system with the correct polarity remains equally important in order to preserve the proper ambience and directionality of the program material.

To connect the supplied speaker wires to the satellite and center speaker terminals, press the red or black plastic cap for the desired terminal, insert the bare end of the wire into the hole below the cap and release the cap. Gently tug on the

wire to make sure that it is fully inserted.

To use the binding-post speaker terminals on the subwoofer, unscrew the colored collar until the pass-through hole in the center post is visible under the collar. Insert the bare end of the wire through this hole; then screw the collar down until the connection is tight. The hole in the center of each collar is intended for use with banana-type connectors. To comply with European CE certification, these holes are blocked with plastic inserts at the point of manufacture. To use banana-type connectors requires the removal of the inserts. Do not remove these inserts if you are using the product in an area covered by the European CE certification.

DOLBY® DIGITAL OR DTS® (OR OTHER DIGITAL SURROUND MODE) CONNECTION

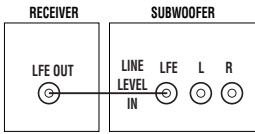

Use this installation method for Dolby® Digital, DTS® or other digital surround processors:

Use the line-level input jack marked “LFE” for the Low-Frequency Effects channel. Connect this jack to the LFE

output or subwoofer output on your receiver or amplifier. Connect each speaker to the corresponding speaker terminals on your receiver or amplifier.

Make sure that you have configured your surround sound processor for “Subwoofer On”.

For the SCS200.6 system, the receiver should be configured for 6.1-channel operation. For both the SCS200.5

and SCS200.6 systems, the front left, front right, center and rear speakers should all be set to “Small.”

If your receiver allows you to set the crossover frequency between the subwoofer and the main speakers, select 120Hz or the setting that is the closest frequency below it.

DOLBY PRO LOGIC® (NON-DIGITAL) – LINE LEVEL

Use this installation method for Dolby Pro Logic® applications (not Dolby Digital, DTS or other digital processing), where the receiver/processor is equipped with a subwoofer output, or a volume-controlled preamp (line-) level output:

Use RCA-type interconnects to connect the line-level subwoofer outputs on your receiver or amplifier to the line-level inputs on the subwoofer. IMPORTANT: Do not use the LFE input on the subwoofer with Dolby Pro Logic processors.

NOTE: If your receiver or amplifier only has one subwoofer output jack, then you will need to use a Y-connector (not included). Plug the male end of the Y-connector into your receiver or amplifier’s subwoofer output jack, and connect each of the two female ends to separate RCA-type interconnects.

Finally, plug the RCA-type interconnects into the line-level inputs on the subwoofer.

Connect each speaker to the corresponding speaker terminals on your receiver or amplifier.

Make sure your receiver or processor is correctly configured to indicate that the subwoofer is “On.”

Note for advanced users: If your receiver/processor has a built-in low-pass crossover filter for the subwoofer output, you may use the LFE input to bypass the subwoofer’s internal crossover.

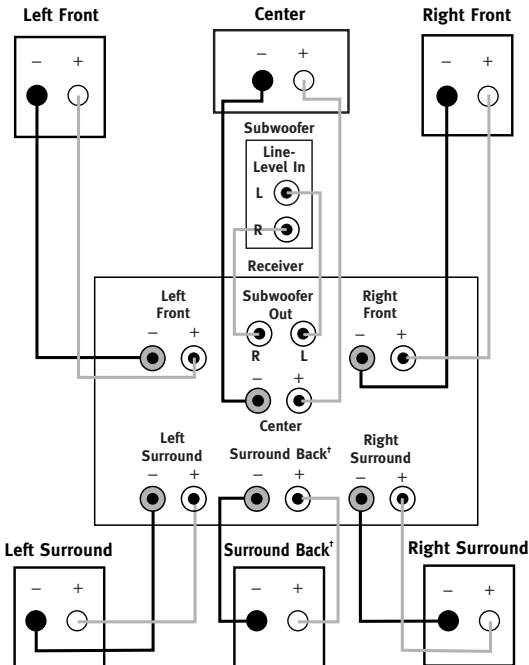

DOLBY PRO LOGIC (NON-DIGITAL) - SPEAKER LEVEL

Use this installation method for Dolby Pro Logic applications (not Dolby Digital, DTS or other digital processing), where the receiver/processor does not have a subwoofer output, or a volume-controlled preamp (line-) level output:

Connect your receiver or amplifier's front left and right speaker terminals to the left and right terminals on the subwoofer that are marked "Speaker Level In." Connect the left and right terminals on the subwoofer that are marked "Speaker Level Out" to the corresponding terminals on the back of your front left and right speakers.

Connect your receiver or amplifier's center, surround and surround back speaker terminals to the corresponding terminals on the back of your center and surround speakers.

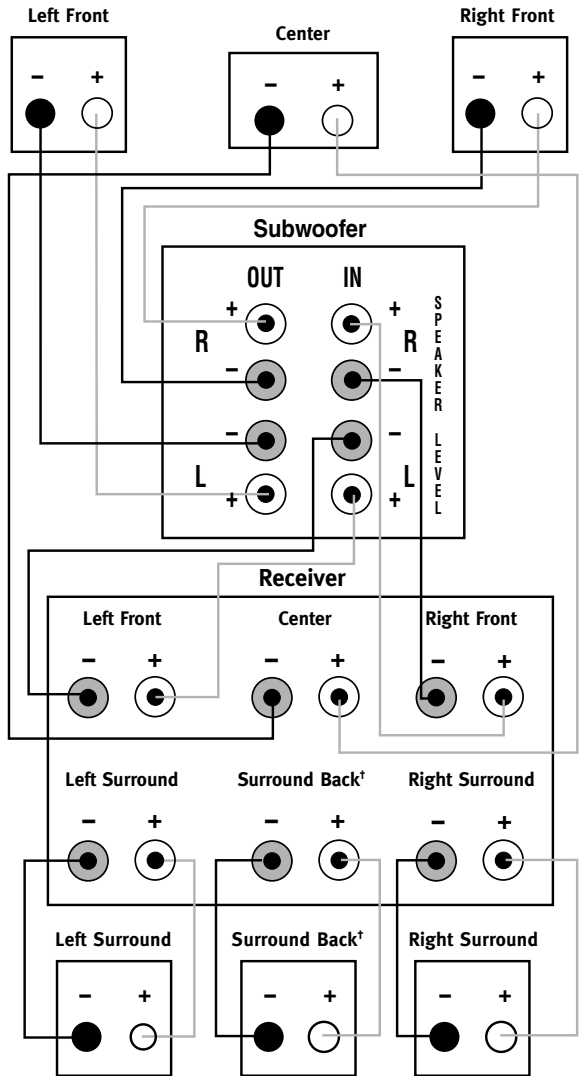

[†] Surround back speaker is used only in SCS200.6 system.

OPERATION

Move the Master Power switch (marked "Power" **A**) to the "•" (On) position to use the SUB200 subwoofer.

If you will be away from home for an extended period of time, or if the subwoofer will not be used, switch the Master Power switch **A** to the Off position.

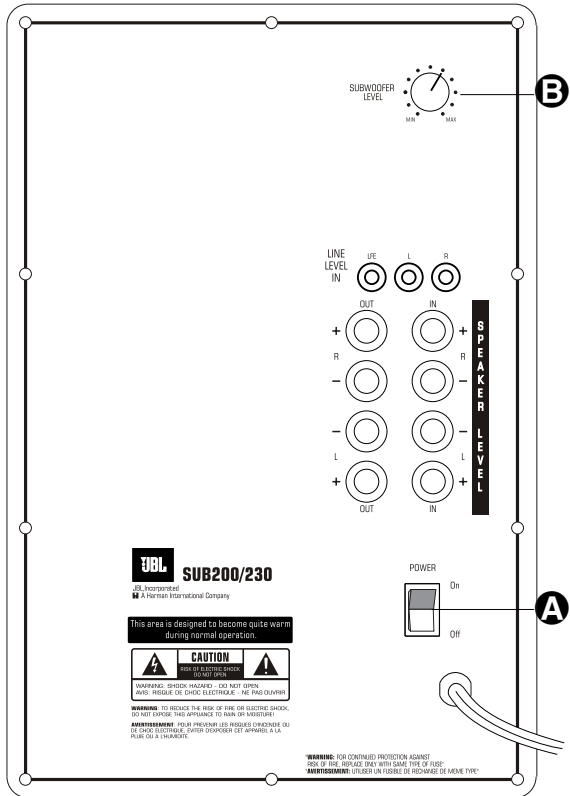

VOLUME

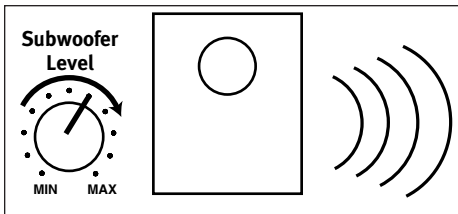

Volume may be adjusted using the Subwoofer Level control **B** as shown.

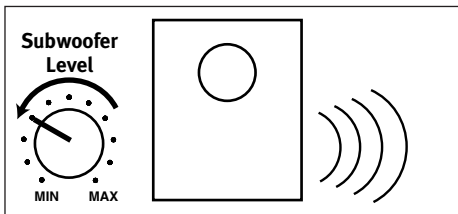

TROUBLESHOOTING

If there is no sound from any of the speakers:

- Check that receiver/amplifier is on and a source is playing.
- Check that the powered subwoofer is plugged in, and its Power switch **A** is switched on (“•” position).
- Check all wires and connections between receiver/amplifier and speakers. Make sure all wires are connected. Make sure none of the speaker wires are frayed, cut or punctured, or touching each other.
- Review proper operation of your receiver/amplifier.

If there is no sound coming from one speaker:

- Check the “Balance” control on your receiver/amplifier.
- Check all wires and connections between receiver/amplifier and speakers. Make sure all wires are connected. Make sure none of the speaker wires are frayed, cut or punctured, or touching each other.
- In Dolby Digital or DTS modes, make sure that the receiver/processor is configured so that the speaker in question is enabled.
- Turn off all electronics and switch the speaker in question with one of the other speakers that is working correctly. Turn everything back on, and determine whether the

problem has followed the speaker, or has remained in the same channel. If the problem is in the same channel, the source of the problem is most likely with your receiver or amplifier, and you should consult the owner’s manual for that product for further information. If the problem has followed the speaker, consult your dealer for further assistance or, if that is not possible, visit www.jbl.com.

If there is no sound from the center speaker:

- Check all wires and connections between receiver/amplifier and speaker. Make sure all wires are connected. Make sure none of the speaker wires are frayed, cut or punctured, or touching each other.
- If your receiver/processor is set in Dolby Pro Logic mode, make sure the center speaker is not in phantom mode.
- If your receiver/processor is set in one of the Dolby Digital or DTS modes, make sure the receiver/processor is configured so that the center speaker is enabled.

If the system plays at low volumes but shuts off as volume is increased:

- Check all wires and connections between receiver/amplifier and speakers. Make sure all wires are connected. Make sure none of the speaker wires are frayed, cut or punctured, or touching each other.
- If more than one pair of main speakers is being used, check the minimum impedance requirements of your receiver/amplifier.

If there is low (or no) bass output:

- Make sure the connections to the left and right “Speaker Inputs” have the correct polarity (+ and –).
- Make sure the subwoofer is plugged into an active electrical outlet, and is turned on (Power switch **A** in the “•” position).
- In Dolby Digital or DTS modes, make sure your receiver/processor is configured so that the subwoofer and LFE output are enabled.

If there is no sound from the surround speakers:

- Check all wires and connections between receiver/amplifier and speakers. Make sure all wires are connected. Make sure none of the speaker wires are frayed, cut or punctured, or touching each other.
- Review proper operation of your receiver/amplifier and its surround sound features.
- Make sure the movie or TV show you are watching is recorded in a surround sound mode. If it is not, check to see whether your receiver/amplifier has other surround modes you may use.
- In Dolby Digital or DTS modes, make sure your receiver/processor is configured so that the surround speakers are enabled. When all five satellites are in use, remember to configure your receiver or processor for 6.1-channel operation.
- Review the operation of your DVD player and the jacket of your DVD to make sure that the DVD features the desired Dolby Digital or DTS mode, and that you have properly selected that mode using both the DVD player's menu and the DVD disc's menu.

SPECIFICATIONS

SCS200.5/230 AND SCS200.6/230 SYSTEMS

Frequency Response 35Hz – 20kHz (–6dB)

SATELLITES

Maximum Recommended Amplifier Power
100 Watts

Power Handling (Continuous/Peak)
50W/160W

Nominal Impedance 8 Ohms

Sensitivity 86dB @ 1 Watt/1 meter

Frequency Response 110Hz – 20kHz (–6dB)

Tweeter

One 13mm (1/2") titanium-laminate dome,
video-shielded

Midrange

One 75mm (3") driver, video-shielded

**Dimensions (H x W x D) (not including shelf
stands)** 184 x 102 x 89mm (7-1/4" x 4" x 3-1/2")

Weight 0.8kg (1.75 lb)

CENTER

Maximum Recommended Amplifier Power
100 Watts

Power Handling (Continuous/Peak)
50W/200W

Nominal Impedance 8 Ohms

Sensitivity 88dB @ 1 Watt/1 meter

Frequency Response 100Hz – 20kHz (–6dB)

Tweeter

One 13mm (1/2") titanium-laminate dome,
video-shielded

Midrange

Dual 75mm (3") drivers, video-shielded

**Dimensions (H x W x D) (not including shelf
stand)** 102 x 292 x 89mm (4" x 11-1/2" x 3-1/2")

Weight 1.4kg (3 lb)

SUBWOOFER

Amplifier 100 Watts RMS

Frequency Response 35Hz – 160Hz (–6dB)

Woofer 200mm (8")

Enclosure Bass reflex

Dimensions (H x W x D) (including feet)

413 x 279 x 349mm (16-1/4" x 11" x 13-3/4")

Weight 12.7kg (28 lb)

All features and specifications are subject to change
without notice.

*Trademarks of Dolby Laboratories.

DTS is a registered trademark of Digital Theater Systems, Inc.

Declaration of Conformity



We, Harman Consumer Group International
2, route de Tours
72500 Chateau-du-Loir
France

declare in own responsibility that the products described in this
owner's manual are in compliance with technical standards:

EN 61000-6-3:2001
EN 61000-6-1:2001
EN 55013:2001
EN 55020:2002
EN 61000-3-2:2000
EN 61000-3-3:1995+A1:2001
EN 60065:2002

Gary Mardell
Harman Consumer Group International
Chateau-du-Loir, France 05/04

OWNER'S GUIDE

PRODUCT LINE:
**SURROUND CINEMA
SPEAKERS**

MODEL: SCS200.5/230 and SCS200.6/230

DESIGN GOAL: Bring the thrill of live performance and movie sound
to the home environment by calling on JBL's professional engineering leadership.

SATELLITE TYPE: Titanium-laminate-dome tweeter,
sealed enclosure

SUBWOOFER TYPE: Bass-reflex enclosure

PORT DESIGN: FreeFlow™ flared

PROFESSIONAL REFERENCE: Cinema Loudspeaker Series



**PRO SOUND
COMES HOME™**

JBL Consumer Products
250 Crossways Park Drive, Woodbury, NY 11797
Europe: 2, Route de Tours, 72500 Chateau du Loir, France
www.jbl.com

© 2004 Harman International Industries, Incorporated

JBL is a registered trademark of
Harman International Industries, Incorporated.

Part No. 406-000-00955

H A Harman International Company